



Longchamp
ARCHITECTURAL INC.

www.longchamparchitectural.com

Product List

STANDARD



Cornices
page 5

A horizontal molded projection crowning a room or a structure



Friezes
page 31

A large panel which typically places under the cornice and over the panel moulding



Panel Moulding
page 37

A running strip usually set below the frieze or applied as chair rails or wainscotting



Medallions
page 55

An oval or circular design typically surrounding a hanging light fixture

SPECIALTY

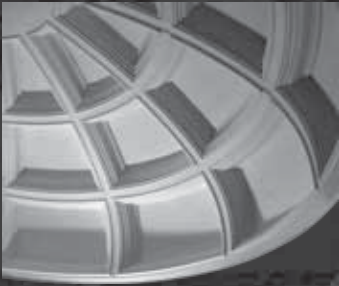

Domes
page 71

A rounded vault forming the ceiling of a large hall or structure



Columns
page 77

An upright pillar, available in cylindrical and square commonly under an overhang



Brackets
page 93

A right-angled support attached to a wall for holding a shelf, pediment or other object



Ceiling Tiles
page 99

Square or circular pieces of sculpted plaster used to decorate the ceiling

CUSTOM WORK



Custom Sculpting & Patterns
p. 103

Employing artistic technique, precision tools and clean cut methods, nearly anything can be created by Longchamps Architectural Inc.'s finest sculptors



Cornices

CONTENTS

Plain Profiles	page 6-15
Enriched Profiles	page 16-27
Center Piece Profile Sets	page 26
Frieze-Type Profiles	page 27-29

height (h) x projection (p)

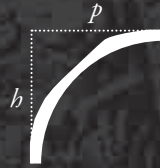
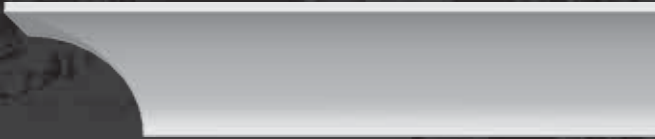

176 4 1/2" x 4 1/2"
114mm x 114mm

177 6 1/2" x 6 1/2"
165mm x 165mm

178 8 1/2" x 8 1/2"
216mm x 216mm

179 10 1/2" x 10 1/2"
267mm x 267mm

180 12 1/2" x 12 1/2"
318mm x 318mm

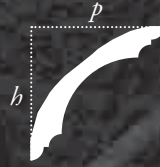

145 2 1/8" x 2 1/8"
54mm x 54mm



152 2 1/4" x 1 9/16"
57mm x 40mm

153 3" x 2 1/8"
76mm x 54mm

154 4 7/8" x 3 1/2"
124mm x 89mm



156 2 1/2" x 1 5/8"
64mm x 41mm

157 2 3/4" x 1 3/4"
70mm x 44mm

158 3" x 2"
76mm x 51mm



164 2 1/4" x 2 1/4"
57mm x 57mm



165 2 3/4" x 2 3/4"
70mm x 70mm

height (h) x projection (p)

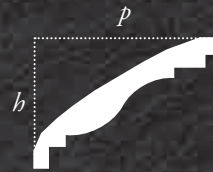

167 2 1/8" x 3"
54mm x 76mm

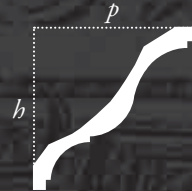
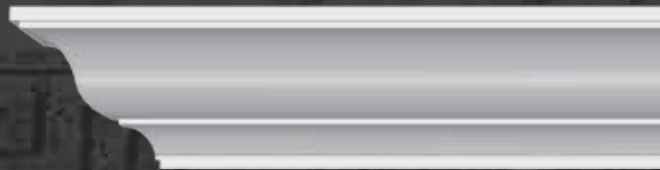

181 3 1/16" x 3 1/16"
78mm x 78mm

182 4" x 4"
102mm x 102mm

183 5 1/8" x 5 1/8"
130mm x 130mm

184 5" x 4"
260mm x 171mm

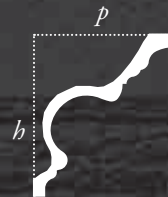

125 3 1/2" x 3"
89mm x 76mm

126 4 1/2" x 4"
114mm x 102mm

127 5 3/4" x 5"
146mm x 127mm

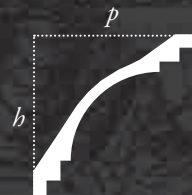
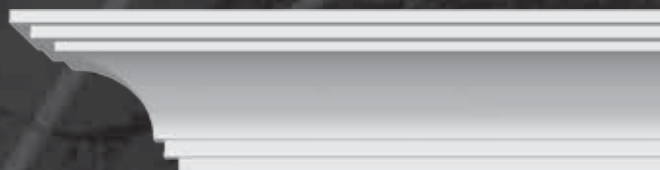

133 2 1/8" x 3 1/8"
79mm x 79mm

134 4 3/4" x 4 3/4"
121mm x 121mm

135 5 1/2" x 1 1/2"
140mm x 140mm

136 6 1/2" x 6 1/2"
165mm x 165mm

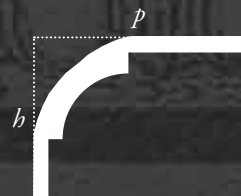
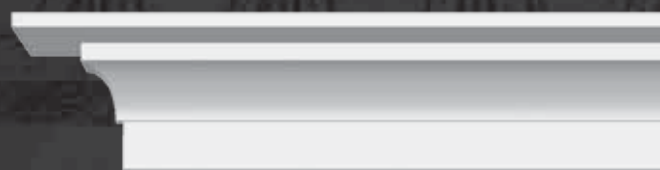

146 3 1/8" x 4 1/8"
79mm x 105mm



155 3 1/2" x 2 3/4"
89mm x 70mm

height (h) x projection (p)

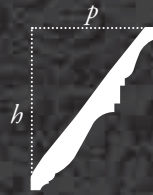
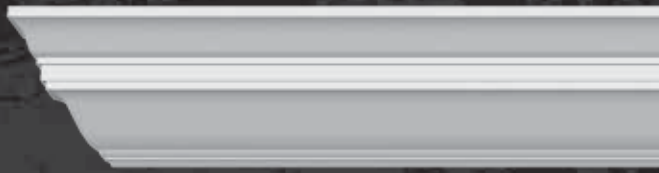

159 3 1/4" x 2 1/2"
83mm x 64mm



163 3 1/8" x 2"
79mm x 51mm

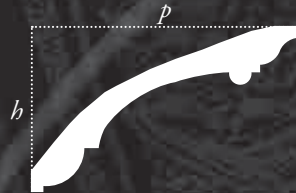

168 3 1/8" x 5 1/2"
79mm x 140mm

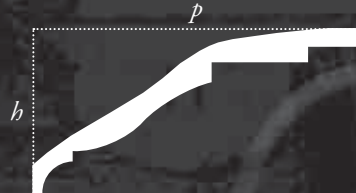

170 3" x 6"
76mm x 152mm

171 3" x 5"
76mm x 127mm

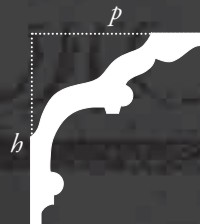

114 3 7/8" x 3 1/2"
98mm x 89mm

115 4 1/2" x 4"
114mm x 102mm



111 4" x 2 7/8"
102mm x 73mm

height (h) x projection (p)

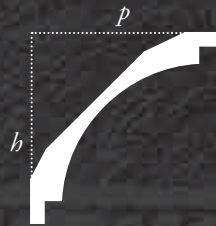
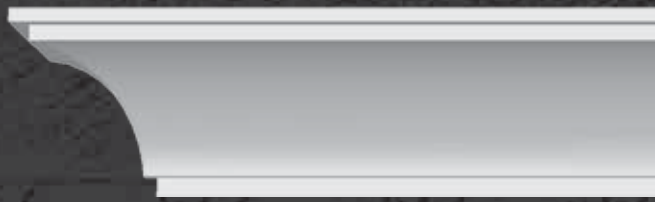

141 4 1/4" x 4 1/4"
108mm x 108mm
142 6" x 6"
152mm x 152mm
143 6 1/2" x 6 1/2"
165mm x 165mm

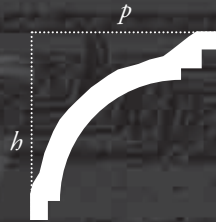
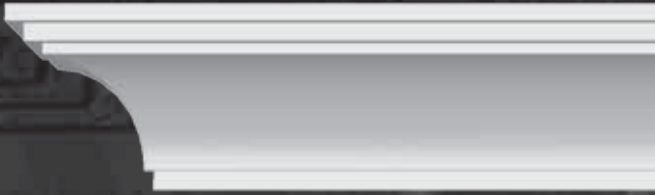

144 4" x 4"
102mm x 102mm

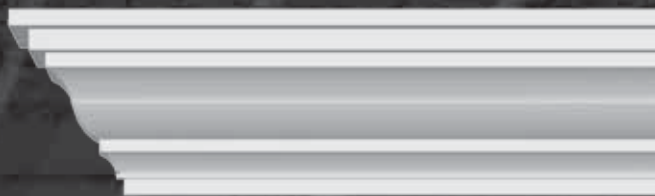

161 4 1/4" x 3 1/2"
108mm x 89mm
162 3 1/4" x 2 1/2"
83mm x 64mm



174 4 3/4" x 6 1/8"
121mm x 156mm
175 5 3/4" x 8 1/4"
146mm x 210mm

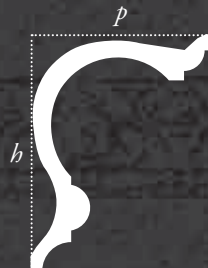

118 5" x 4"
127mm x 102mm
119 4" x 3 1/8"
102mm x 86mm

height (h) x projection (p)

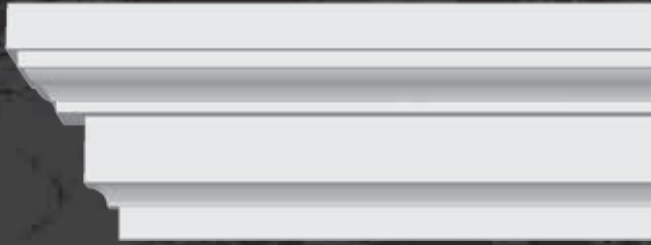

160 5" x 3"
127mm x 67mm

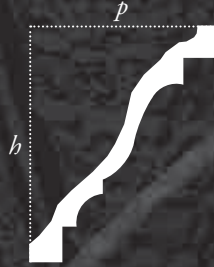
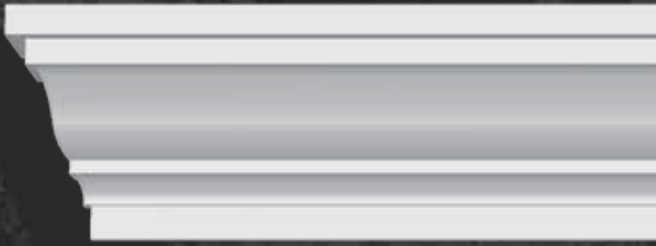

137 5" x 5 3/4"
127mm x 146mm

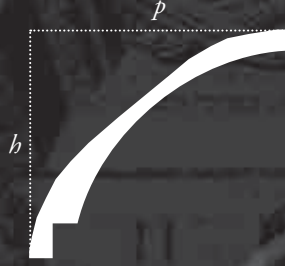
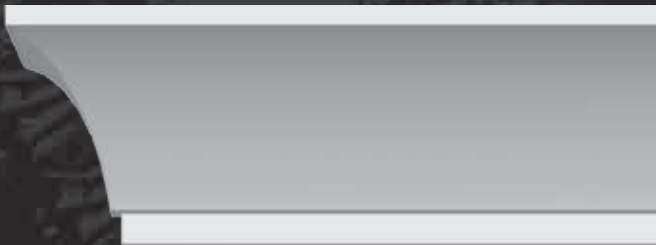

129 5" x 5"
127mm x 127mm

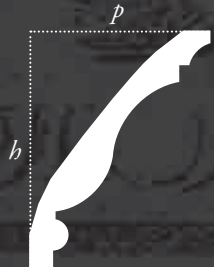
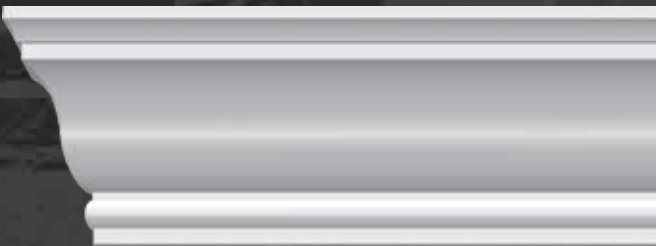

149 5 5/16" x 3 7/8"
135mm x 98mm

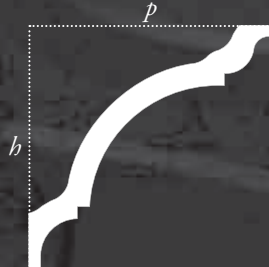
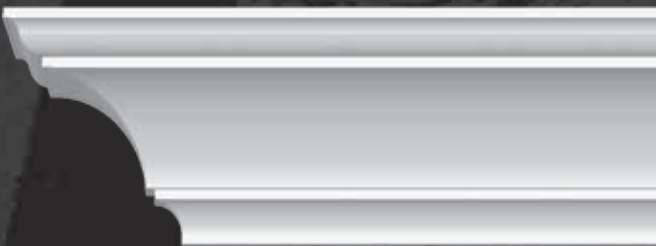

300 5" x 5"
127mm x 127mm

301 7" x 7"
179mm x 179mm

302 9" x 9"
229mm x 229mm

height (h) x projection (p)

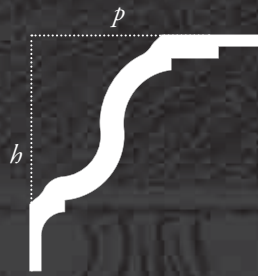

306 5" x 5"
127mm x 127mm
307 7" x 7"
179mm x 179mm
308 9" x 9"
229mm x 229mm

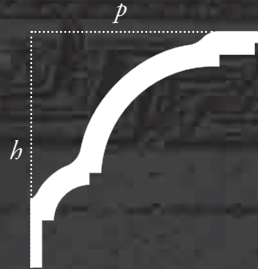

309 5" x 5"
127mm x 127mm
310 7" x 7"
179mm x 179mm
311 9" x 9"
229mm x 229mm

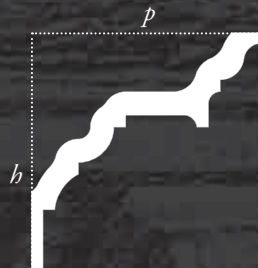
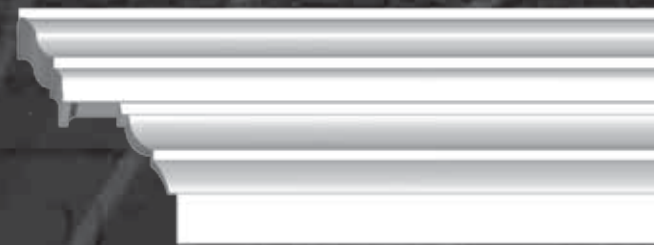

312 5" x 5"
127mm x 127mm
313 7" x 7"
179mm x 179mm
314 9" x 9"
229mm x 229mm

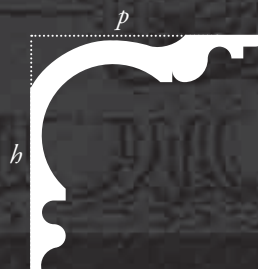

315 5" x 5"
127mm x 127mm
316 7" x 7"
179mm x 179mm
317 9" x 9"
229mm x 229mm

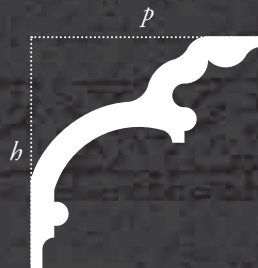

318 5" x 5"
127mm x 127mm
319 7" x 7"
179mm x 179mm
320 9" x 9"
229mm x 229mm

height (h) x projection (p)

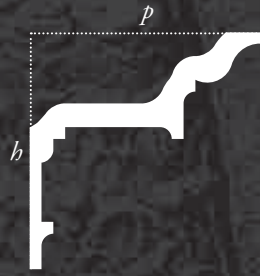

- 324 5" x 5"
127mm x 127mm
- 325 7" x 7"
179mm x 179mm
- 326 9" x 9"
229mm x 229mm

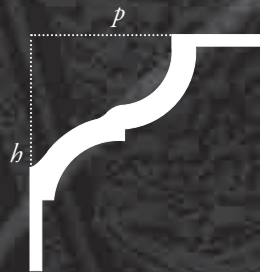
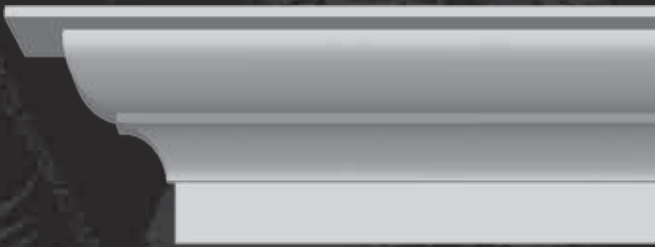

- 327 5" x 5"
127mm x 127mm
- 328 7" x 7"
179mm x 179mm
- 329 9" x 9"
229mm x 229mm

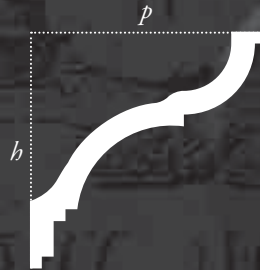
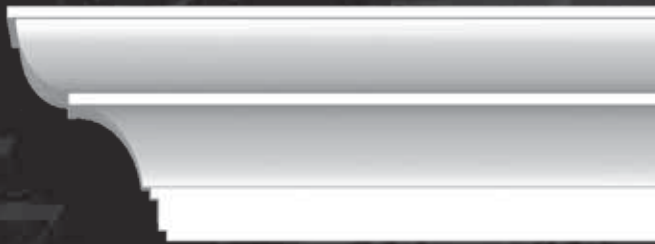

- 330 5" x 5"
127mm x 127mm
- 331 7" x 7"
179mm x 179mm
- 332 9" x 9"
229mm x 229mm

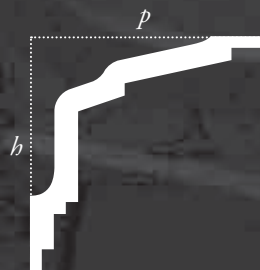
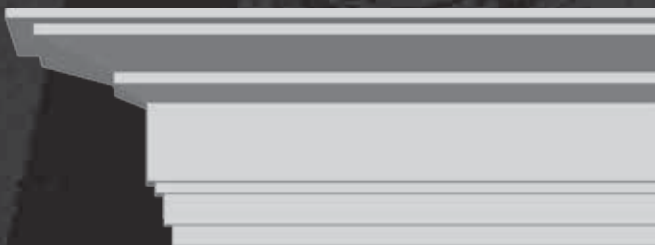

- 333 5" x 5"
127mm x 127mm
- 334 7" x 7"
179mm x 179mm
- 335 9" x 9"
229mm x 229mm

height (h) x projection (p)

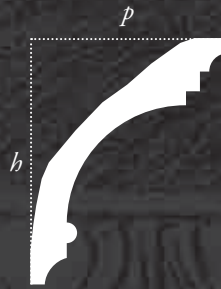
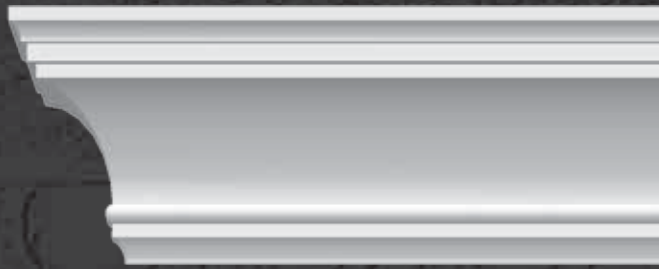

103 6 1/4" x 6"
159mm x 152mm

104 5" x 3 3/4"
127mm x 95mm

105 4" x 2 3/4"
102mm x 70mm

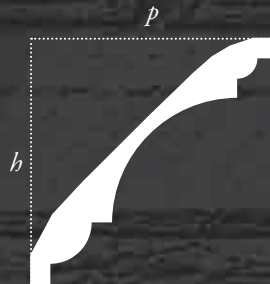
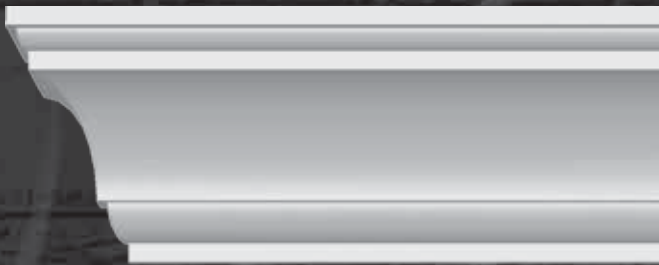

110 6" x 6"
152mm x 152mm

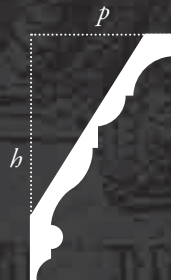
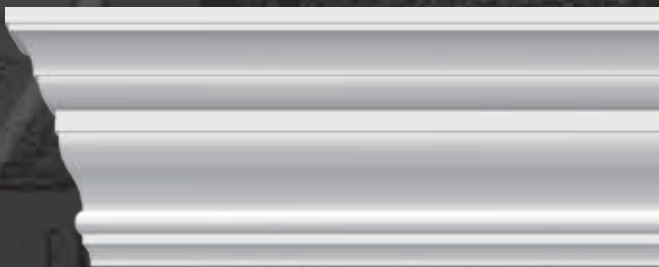

130 6" x 3 5/8"
152mm x 92mm



131 6 1/2" x 6"
165mm x 152mm

height (h) x projection (p)

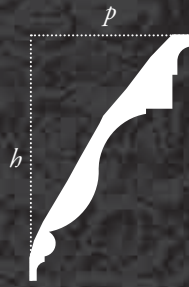

150 6 1/4" x 4 1/8"
159mm x 105mm

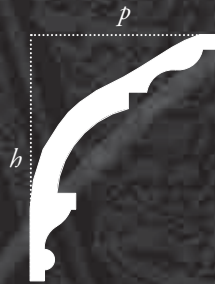

151 6 1/2" x 5"
165mm x 127mm

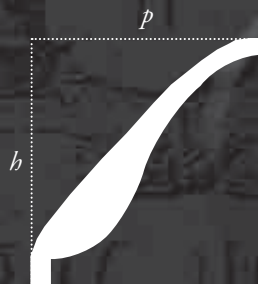
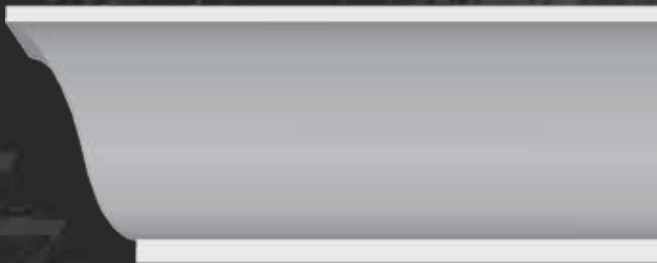

116 7 5/8" x 7 1/4"
194mm x 184mm

117 5 3/8" x 4 1/4"
137mm x 108mm

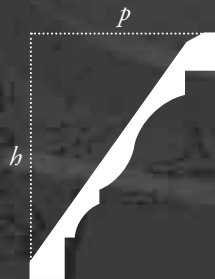
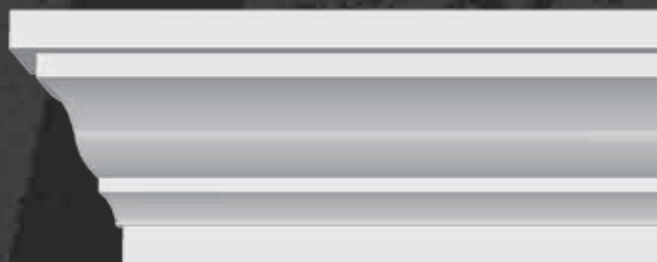

128 7 15/16" x 6 1/8"
202mm x 156mm

height (h) x projection (p)

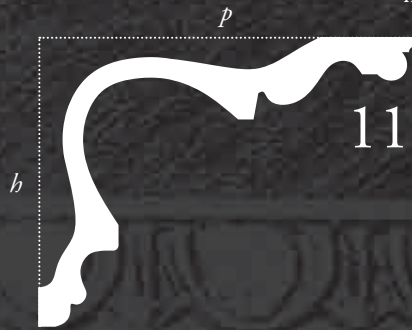

112 7 1/16" x 9 3/16"
179mm x 233mm

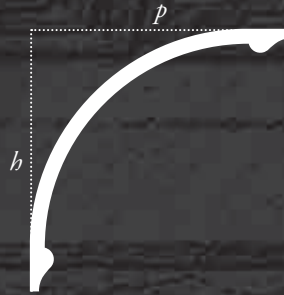
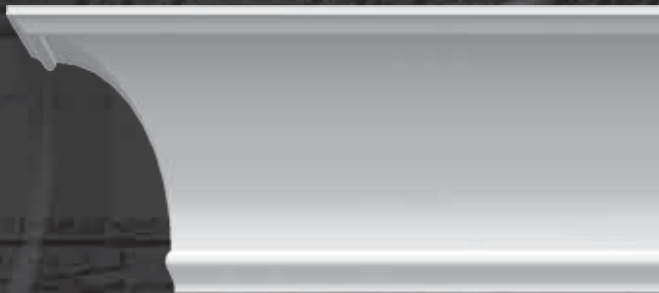

147 7" x 7"
178mm x 178mm

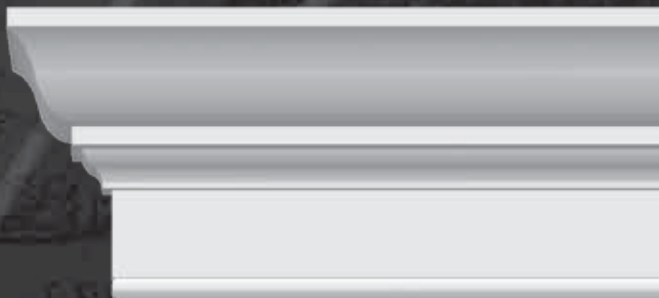

172 10 1/4" x 6 3/4"
260mm x 171mm



108 16 1/4" x 11 3/8"
413mm x 289mm

height (h) x projection (p)

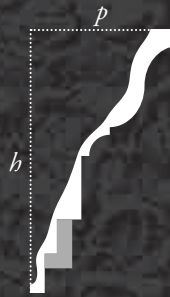

200 6 3/4" x 3 3/4"
171mm x 95mm

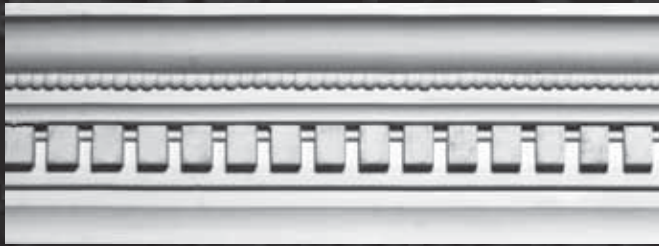

201 5 13/16" x 3 15/16"
148mm x 100mm

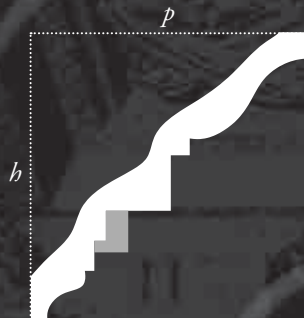

202 7 1/2" x 7 1/2"
191mm x 191mm

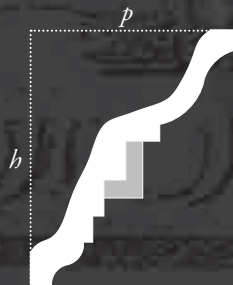

223 7 1/2" x 5 1/4"
191mm x 133mm

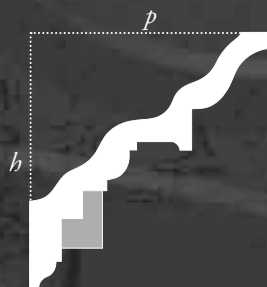

222 6 1/8" x 5 3/4"
156mm x 146mm

height (h) x projection (p)

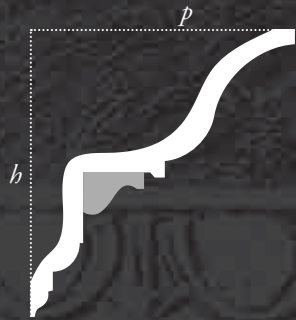

203 7 5/8" x 8 3/4"
194mm x 222mm

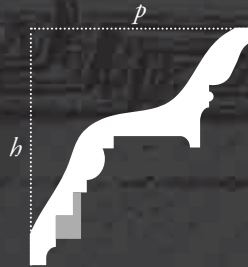

204 5 1/2" x 5 3/16"
140mm x 132mm

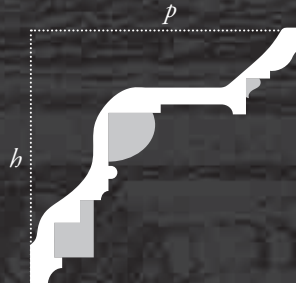

250 6 1/2" x 7 3/16"
165mm x 183mm

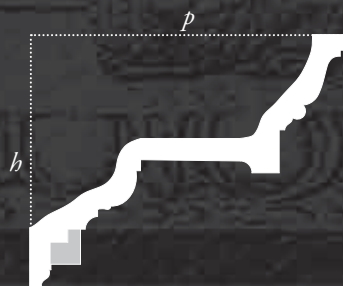

224 6" x 7 1/2"
152mm x 191mm

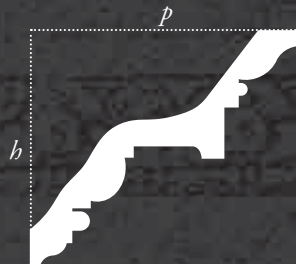

264 5 1/4" x 5 1/4"
133mm x 133mm

height (h) x projection (p)

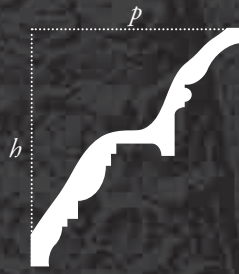

205 5 1/8" x 5 1/8"
130mm x 130mm

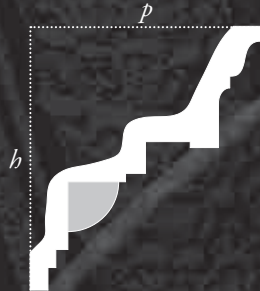

225 6 1/8" x 5 3/4"
156mm x 146mm

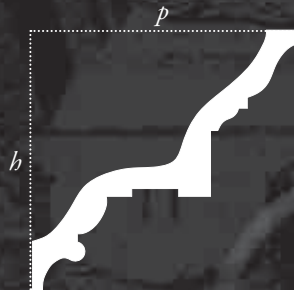

226 6 1/4" x 6 1/2"
159mm x 165mm

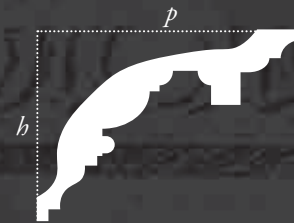

206 4 7/8" x 6 5/8"
124mm x 168mm

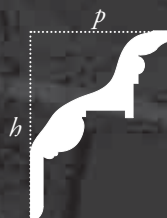

228 4 1/4" x 3 1/8"
108mm x 79mm

height (h) x projection (p)

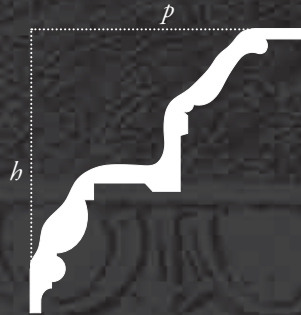

242 7 1/8" x 6 7/8"
181mm x 175mm

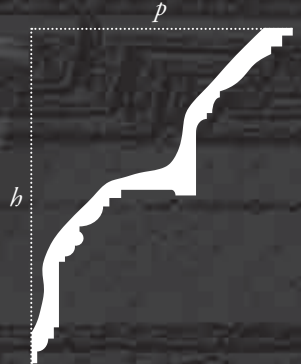

245 10 5/16" x 8 1/16"
262mm x 205mm

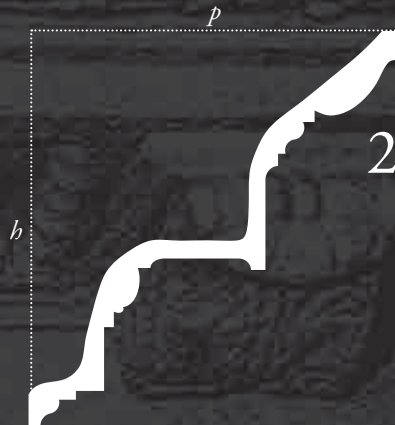

261 11 1/4" x 12"
286mm x 305mm



241 4 5/8" x 3 3/4"
117mm x 98mm

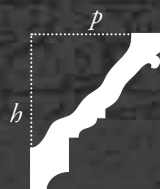

232 3 7/8" x 3 1/4"
98mm x 83mm

height (h) x projection (p)

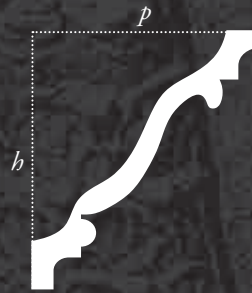

249 6 1/8" x 5 1/16"
156mm x 129mm

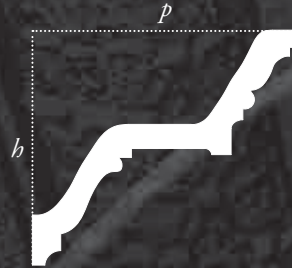

235 5 1/4" x 6"
133mm x 152mm



209 6 1/8" x 3 3/16"
156mm x 81mm

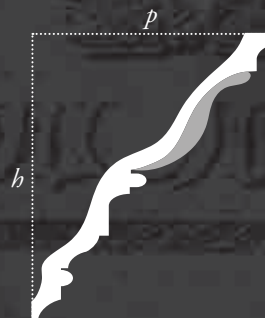

207 7 3/4" x 4 3/8"
196mm x 111mm

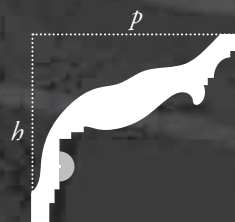

260 3 3/4" x 4 1/2"
95mm x 114mm

height (h) x projection (p)

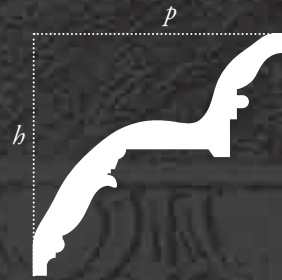

208 5 9/16" x 5 15/16"
141mm x 151mm

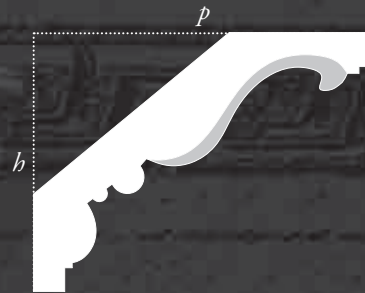

234 6 1/16" x 8"
154mm x 203mm

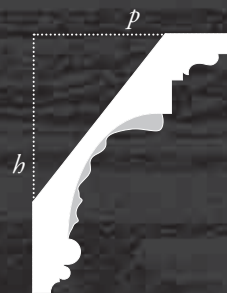

236 6 3/4" x 5 1/8"
171mm x 130mm



210 8 1/2" x 5 5/8"
216mm x 143mm

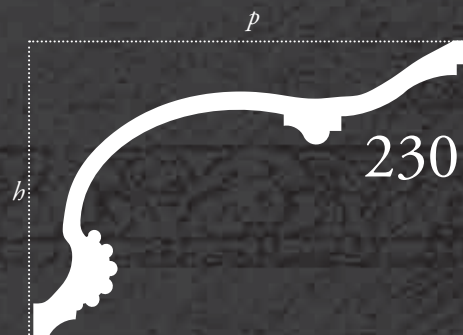
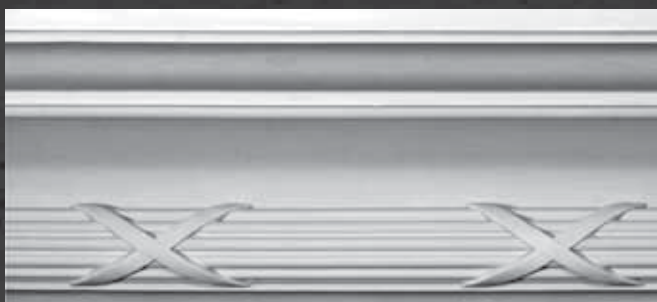

230 8 1/4" x 12 1/8"
210mm x 308mm

height (h) x projection (p)



227 6 5/8" x 6 1/2"
168mm x 165mm

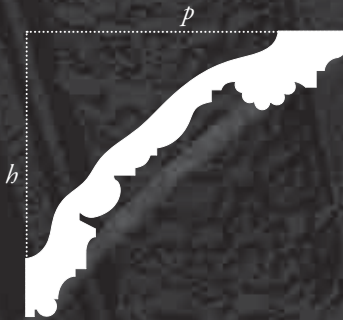

231 7" x 8"
178mm x 203mm

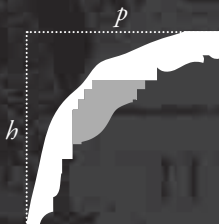

218 4 1/8" x 4 1/4"
105mm x 108mm

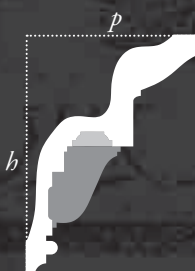

239 7 1/16" x 5 5/16"
179mm x 135mm

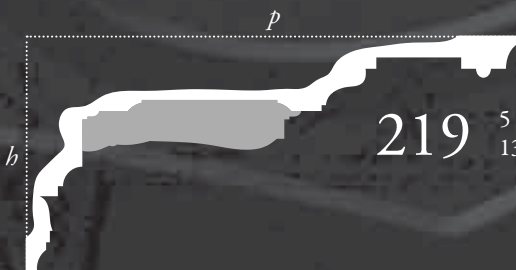

219 5 7/16" x 11 1/4"
138mm x 286mm

height (h) x projection (p)

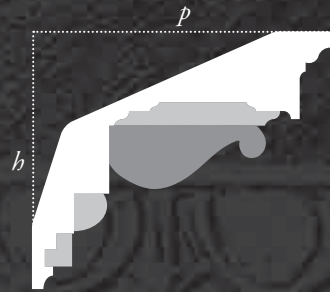

251 5 3/4" x 6 7/8"
146mm x 175mm

Also available without Modillion
Blocks

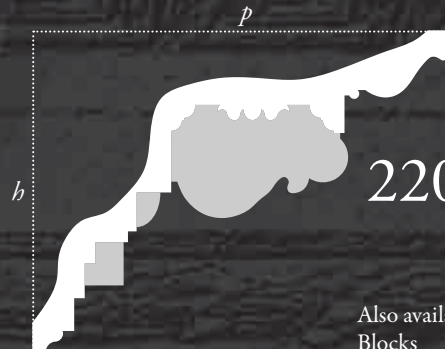

220 9 1/4" x 12 13/16"
235mm x 325mm

Also available without Modillion
Blocks

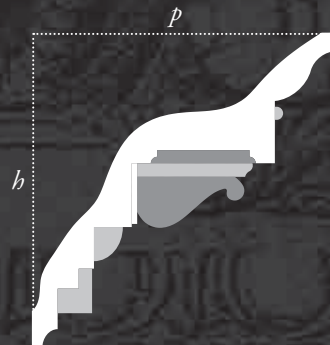

247 10 1/16" x 9 15/16"
256mm x 252mm

Also available without Modillion
Blocks

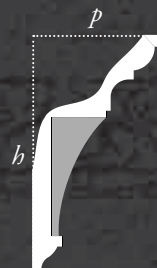

213 5 3/4" x 3 1/8"
146mm x 79mm

height (h) x projection (p)

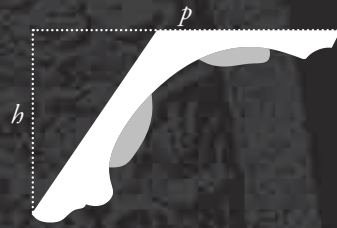

262

2 1/4" x 4 3/4"
57mm x 121mm

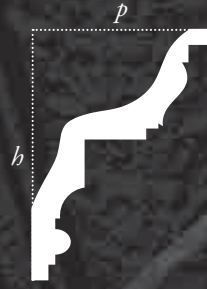

211

5 3/8" x 3 7/8"
137mm x 98mm

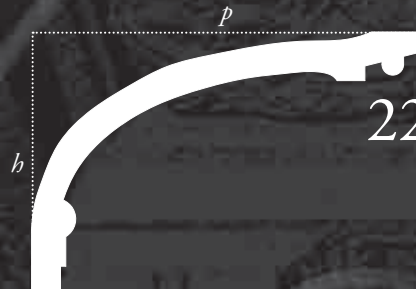
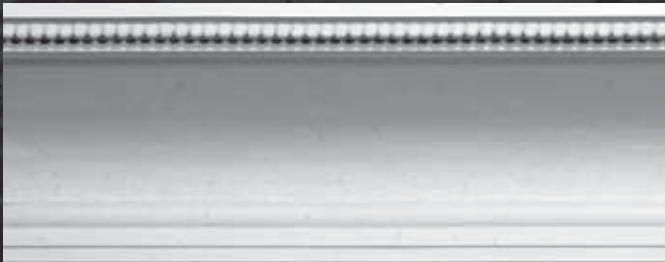

229

5 1/2" x 8 1/4"
138mm x 210mm

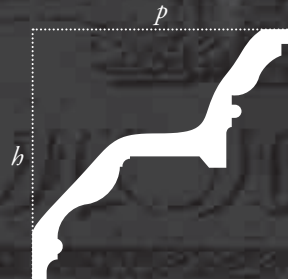

265

6" x 6"
152mm x 152mm

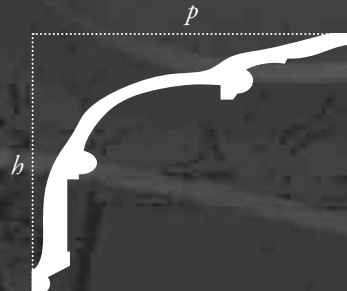

212

6 7/8" x 8 3/8"
175mm x 213mm

height (h) x projection (p)

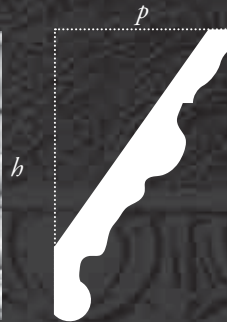

259 7" x 4 1/2"
178mm x 114mm

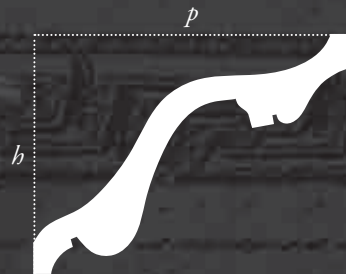

216 5 7/16" x 7 1/2"
138mm x 191mm

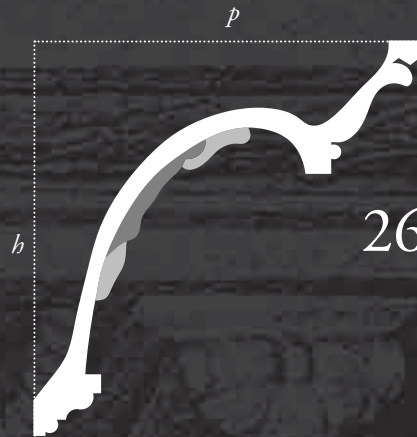

267 6" x 6 1/8"
152mm x 156mm

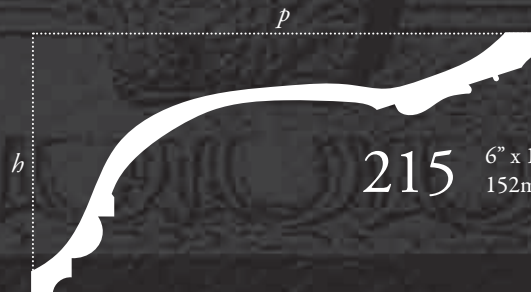

215 6" x 11 5/8"
152mm x 295mm

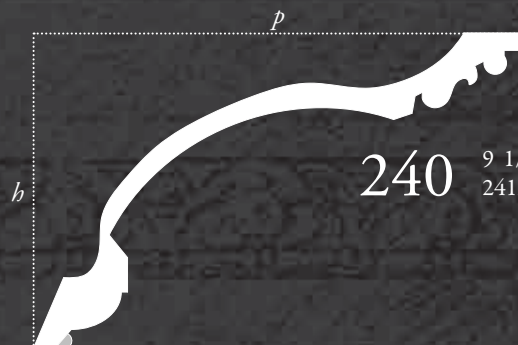

240 9 1/2" x 11"
241mm x 279mm

height (h) x projection (p)

Center Piece Cornice

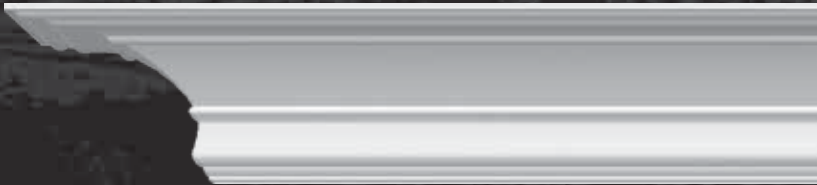

244 7 1/2" x 6 7/8"
191mm x 175mm

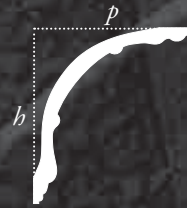

243 7 1/2" x 6 7/8"
191mm x 175mm



233 6 1/2" x 4"
165mm x 102mm

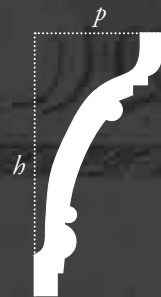

248 6 1/2" x 4"
165mm x 102mm



256 5 1/4" x 2 1/4"
133mm x 57mm



254 3 7/8" x 1"
98mm x 25mm



255 6" x 1 3/4"
152mm x 44mm



257 5 1/16" x 1 15/16"
129mm x 27mm



263 5" x 1 1/4"
127mm x 32mm

height (h) x projection (p)

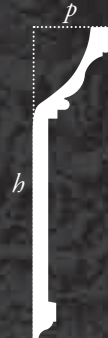

266 10 1/4" x 2 1/2"
260mm x 64mm



217 7 3/8" x 3"
200mm x 76mm

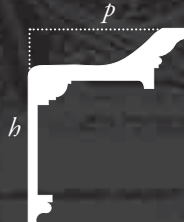

237 4 1/2" x 3 9/16"
114mm x 90mm



258 11 3/8" x 1 1/8"
289mm x 29mm



221 14" x 3 1/2"
356mm x 89mm

height (h) x projection (p)



238 9 3/4" x 2 13/16"
248mm x 71mm

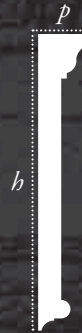

252 8 1/8" x 1 9/16"
206mm x 40mm



253 7" x 1 1/8"
178mm x 29mm
268 8 1/8" x 1 9/16"
206mm x 40mm



Friezes

CONTENTS

Horizontal Friezes page 32-35

Vertical Friezes page 36

Panel Friezes page 37

height (h) x projection (p)



819 1 7/8" x 9/16"
48mm x 14mm



820 2" x 3/8"
51mm x 10mm



832 1 3/4" x 3/8"
44mm x 10mm



826 4 1/2" x 7/8"
114mm x 22mm



809 5 1/4" x 1/2"
133mm x 13mm



818 6" x 9/16"
152mm x 14mm



845 4 9/16" x 13/16"
116mm x 21mm



842 4 1/16" x 3/4"
103mm x 19mm



830 4 7/8" x 3/16"
124mm x 5mm



811 5 7/8" x 3/4"
149mm x 19mm



825 2 1/8" x 3/4"
54mm x 19mm



822 2 1/8" x 1/2"
54mm x 13mm



839 3 7/8" x 5/8"
98mm x 16mm



827 4 1/2" x 11/16"
114mm x 17mm



824 3 3/4" x 9/16"
95mm x 14mm

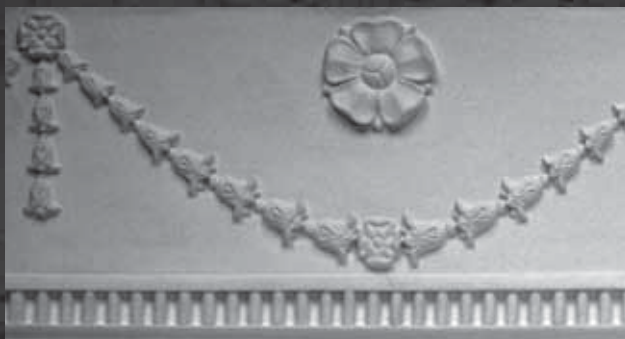

829 7" x 5/8"
178mm x 16mm



805 4 7/8" x 1 1/16"
124mm x 27mm



816 4 3/8" x 7/8"
111mm x 22mm

height (h) x projection (p)



804 5 5/8" x 3/8"
143mm x 10mm



807 9" x 1 1/8"
229mm x 29mm



817 4 5/16" x 5/16"
125mm x 8mm



808 6" x 15/16"
152mm x 24mm



821 2 1/4" x 1/2"
57mm x 13mm



831 7 3/4" x 1 1/16"
197mm x 27mm



812 9 5/16" x 1 1/8"
243mm x 29mm



823 5 1/16" x 9/16"
129mm x 14mm



802 10 5/8" x 1 1/4"
170mm x 32mm

850 7 3/4" x 15/16"
197mm x 27mm



814 10 1/2" x 15/16"
267mm x 24mm



800 10 5/8" x 5/8"
279mm x 16mm

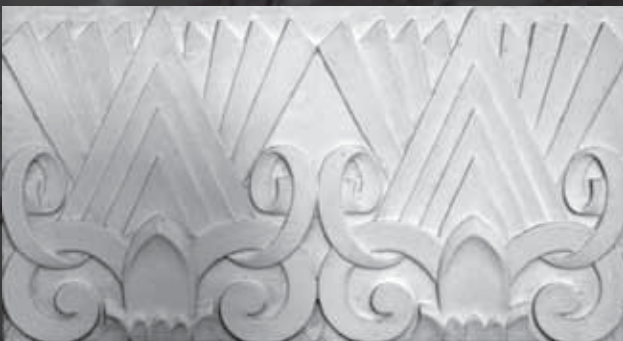

851 7 1/4" x 5/8"
184mm x 16mm



833 4 1/8" x 1/2"
105mm x 13mm

height (h) x projection (p)



838L 9"(h) x 5 3/4" (w) x 5/8"(p)
229mm x 146mm x 16mm



838R 9"(h) x 5 3/4" (w) x 5/8"(p)
229mm x 146mm x 16mm



836 16"(h) x 6"(w) x 1"(p)
406mm x 152mm x 25mm



837 28"(h) x 8"(w) x 1 1/2"(p)
711mm x 203mm x 38mm



828 10 1/4"(h) x 63 3/8"(w) x 1"(p)
260mm x 924mm x 25mm



834 13 3/8"(h) x 85"(w) x 1 15/16"(p)
340mm x 2159mm x 49mm



801 10 1/8"(h) x 81"(w) x 1"(p)
257mm x 2057mm x 25mm

Supplied in 2 pieces



840 15"(h) x 56 3/8"(w) x 1"(p)
381mm x 1432mm x 25mm





Panel

Moulding

CONTENTS

Plain Profiles page 40-43

Enriched Profiles page 44-49

Panel Corners page 50-53

height (h) x projection (p)



700 1" x 3/4"
25mm x 19mm

701 1 15/16" x 1 1/8"
49mm x 29mm

702 2 5/8" x 1 1/2"
67mm x 38mm



725 1" x 1/2"
25mm x 13mm



705 2 3/16" x 15/16"
56mm x 24mm



707 1 7/8" x 3/4"
48mm x 19mm



720 1 1/4" x 1/2"
32mm x 13mm



721 1 1/2" x 1/2"
38mm x 13mm



722 1 1/2" x 9/16"
38mm x 14mm

height (h) x projection (p)



726 1 1/2" x 1/2"
38mm x 13mm



723 1 1/2" x 1/2"
38mm x 13mm

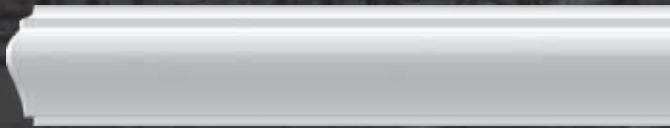

729 1 5/8" x 5/8"
41mm x 16mm

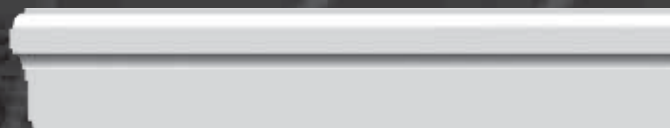

724 1 1/2" x 9/16"
38mm x 14mm



706 2 1/8" x 3/4"
54mm x 19mm



709 2 1/4" x 1"
58mm x 25mm



727 2 1/2" x 7/8"
64mm x 22mm



703 1 3/8" x 5/8"
35mm x 16mm

704 2 5/8" x 1 3/16"
67mm x 46mm

height (h) x projection (p)

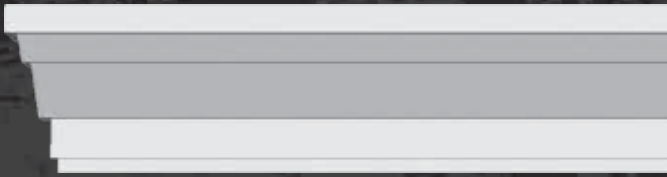

710 3" x 1 1/4"
76mm x 32mm



711 3" x 1 1/4"
76mm x 32mm

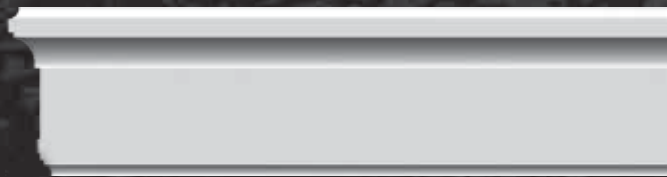

712 3 1/2" x 1 1/4"
89mm x 32mm



708 3 1/8" x 1"
79mm x 25mm

718 2 1/8" x 3/4"
54mm x 19mm



716 3" x 1 3/8"
76mm x 35mm

height (h) x projection (p)



717 3" x 1 1/4"
76mm x 32mm

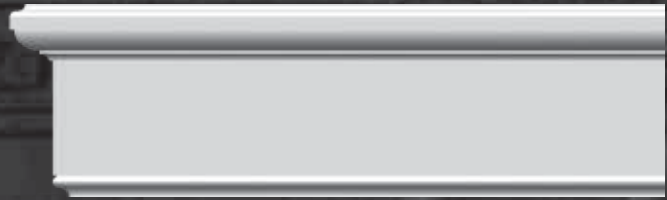

713 4" x 1 5/16"
102mm x 33mm



714 4" x 1 3/8"
102mm x 35mm



715 4" x 1 5/16"
102mm x 49mm

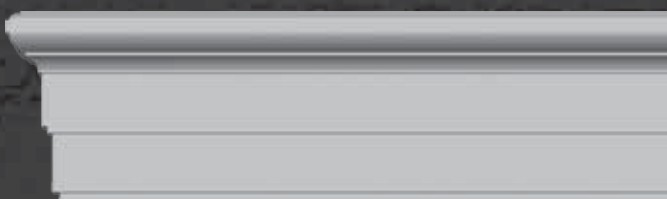

719 4" x 1 9/16"
102mm x 40mm

height (h) x projection (p)

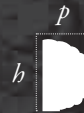

height (h) x projection (p)
757 1" x 1 1/16"
25mm x 27mm



758 1" x 1/2"
25mm x 13mm



754 1 1/4" x 1"
32mm x 25mm



755 1 5/8" x 1 1/16"
41mm x 27mm



756 1 5/8" x 3/4"
41mm x 19mm



763 1 3/4" x 1 1/8"
44mm x 29mm

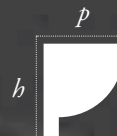

764 1 13/16" x 1 5/8"
46mm x 41mm



766 1 5/8" x 15/16"
41mm x 24mm

height (h) x projection (p)



767 1 13/16" x 7/8"
46mm x 22mm



768 1 3/16" x 1 5/8"
30mm x 41mm

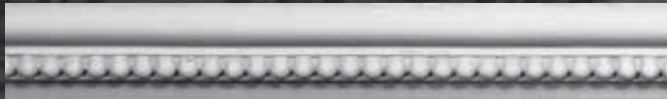

769 1 3/8" x 1 3/16"
35mm x 30mm



770 1 7/16" x 3/4"
37mm x 19mm



796 1 3/4" x 1 7/8"
44mm x 48mm



773 1 1/2" x 1 1/16"
38mm x 27mm



774 1 1/16" x 11/16"
27mm x 16mm



776 1 9/16" x 3/4"
40mm x 19mm

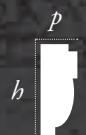

777 1 9/16" x 5/8"
40mm x 16mm

height (h) x projection (p)

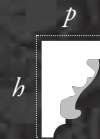

781 1 7/8" x 1 1/4"
48mm x 32mm



750 2 1/8" x 1 3/4"
54mm x 44mm



752 2 9/16" x 2 1/16"
65mm x 52mm



760 2" x 15/16"
51mm x 23mm



761 2 1/4" x 1 1/4"
57mm x 32mm



762 1 1/16" x 3/8"
27mm x 10mm



771 2 1/16" x 1 1/8"
52mm x 29mm



772 2 3/16" x 13/16"
56mm x 21mm



height (h) x projection (p)

782 2" x 1 1/16"
51mm x 27mm



783 2 3/8" x 1 3/16"
60mm x 30mm



787 2 15/16" x 7/8"
75mm x 22mm



784 3" x 11/16"
76mm x 16mm



788 4 1/8" x 13/16"
105mm x 21mm



785 3 3/8" x 1"
86mm x 25mm



786 3 1/8" x 1 5/16"
79mm x 33mm

height (h) x projection (p)



789 4" x 11/16"
102mm x 16mm



765 3 1/4" x 1 9/16"
83mm x 40mm



775 3 1/16" x 7/8"
78mm x 22mm



779 3 1/8" x 1 3/16"
79mm x 30mm



753 3 13/16" x 1"
97mm x 25mm



778 4 5/16" x 2 1/8"
125mm x 54mm

height (h) x projection (p)



780 4 1/16" x 1 9/16"
103mm x 40mm



791 2 7/8" x 1 1/2"
73mm x 38mm

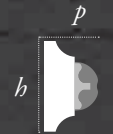

790 1 3/8" x 3/4"
35mm x 19mm



792 3 3/4" x 2 1/4"
95mm x 57mm



793 1 9/16" x 5/8"
39mm x 16mm



794 1 3/8" x 1/2"
35mm x 13mm



795 1 3/8" x 3/8"
35mm x 10mm

height (h) x projection (p)

Panel Corners

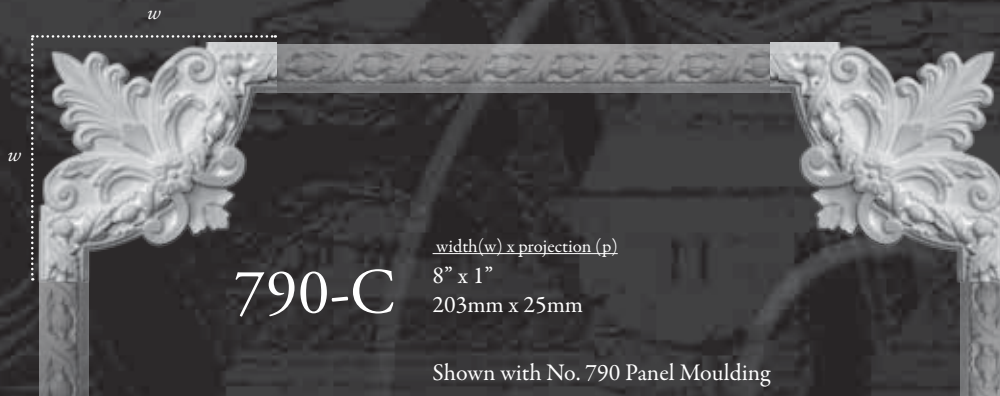

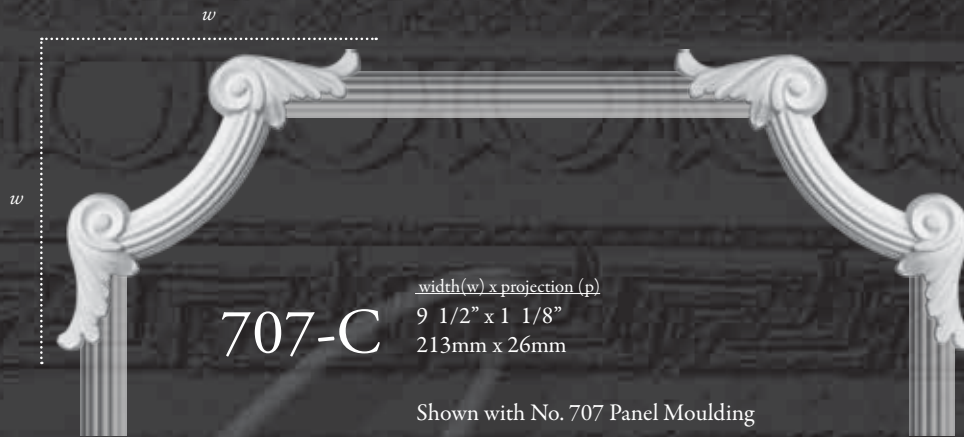

height (h) x projection (p)

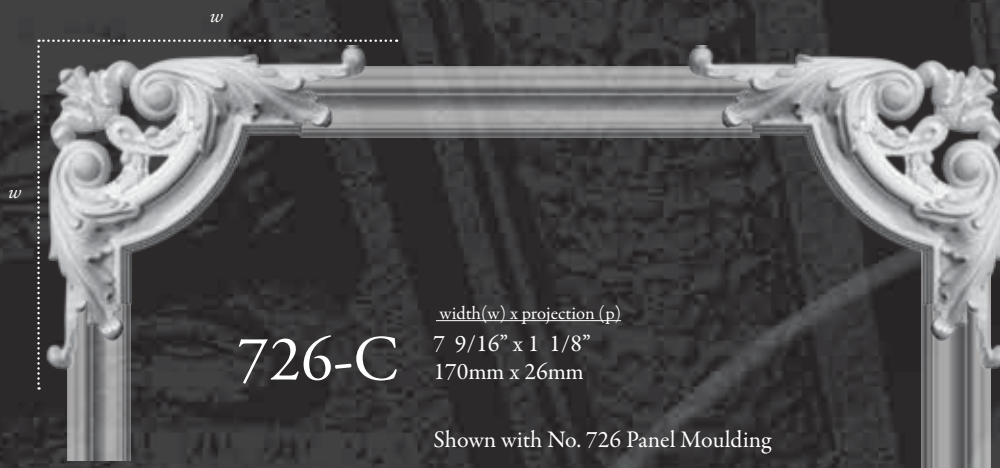





Medallions

CONTENTS

Medallions page 56-62

Swags page 63

Rosettes page 64-69

height (h) x projection (p)



927 \varnothing 12 1/4"
324mm



914 17 1/4"(l) x 12 1/2"(w)
438mm x 318mm



923 \varnothing 15 5/16"
381mm



900 \varnothing 17 1/2"
445mm



915 \varnothing 17"
432mm



902 \varnothing 18"
457mm

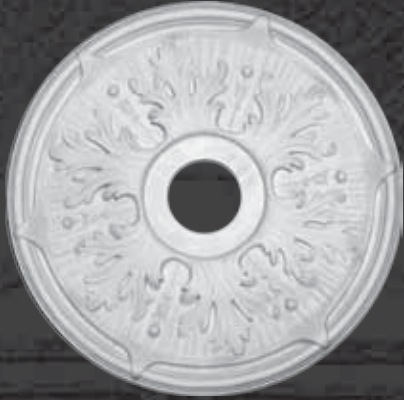

924 \varnothing 18 3/4"
476mm



918 \varnothing 20 3/4"
527mm



913 \varnothing 20 1/4"
514mm

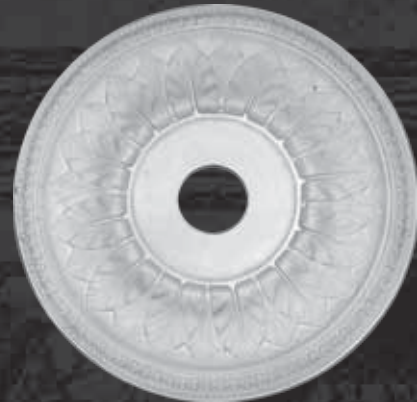

904 \varnothing 20 13/16"
509mm



909 \varnothing 20 3/4"
781mm



906 \varnothing 23 3/16"
589mm

height (h) x projection (p)



926 \varnothing 23 1/4"
591mm



920 \varnothing 26 1/4"
667mm



910 \varnothing 24 3/4"
629mm



916 \varnothing 27 1/4"
692mm



922 \varnothing 25 1/4"
641mm



908 \varnothing 29 1/2"
749mm



907 Ø 30"
762mm

911 Ø 18"
457mm



905 Ø 32 3/4"
832mm



912 Ø 33 1/2"
851mm



917 Ø 33"
838mm

height (h) x projection (p)



901 \varnothing 60"
1524mm
Supplied in Thirds



919 30 1/4"(l) x 26 3/4"(w)
768mm x 679mm



932 17 1/2"(l) x 13 3/4"(w)
445mm x 349mm



925 \varnothing 32 1/2(l)" x 19"(w)
731mm x 428mm



Shown with optional Swags
Part No. 945

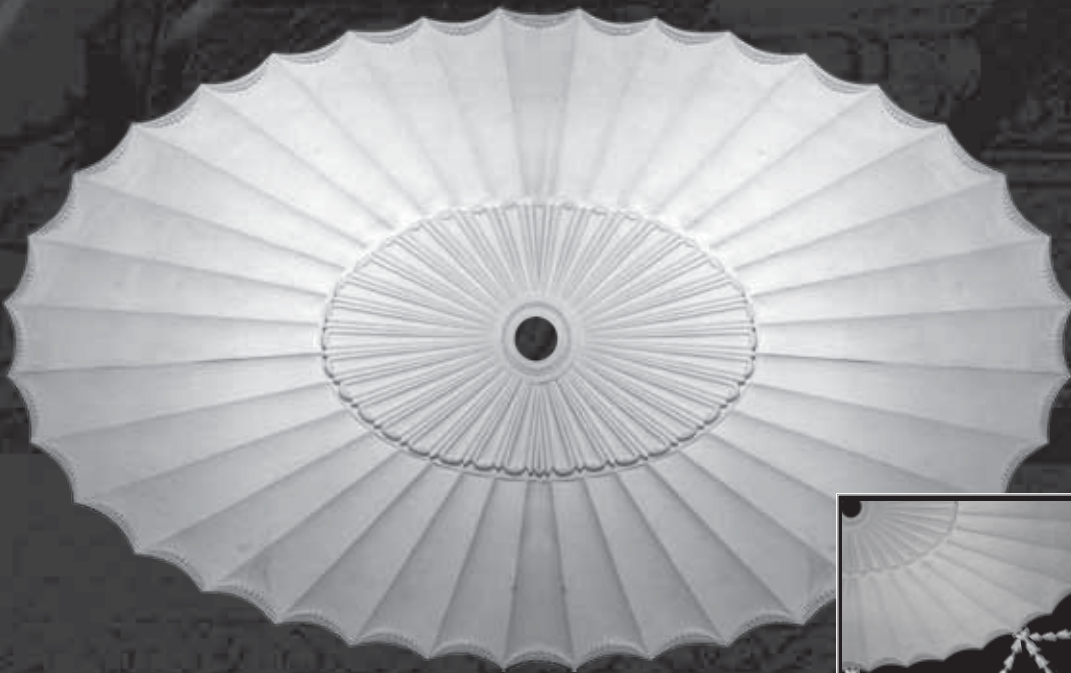

931 49 1/2(l)" x 85"(w)
1257mm x 2159mm

Supplied in halves



Shown with optional Swags
Part No. 946

height (h) x projection (p)



929 43(l)" x 66 1/2"(w)
1092mm x 1689mm



930 37 1/2(l)" x 55 1/2"(w)
953mm x 1410mm

Supplied with a thin backing
around the ornaments

Swags



945 10 1/2(w)" x 4 1/2"(h)
267mm x 114mm

946 27"(w) x 12"(h)
686mm x 305mm

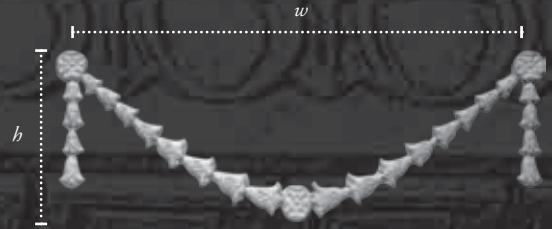

948 14 1/2(w)" x 5 1/4"(h)
368mm x 133mm

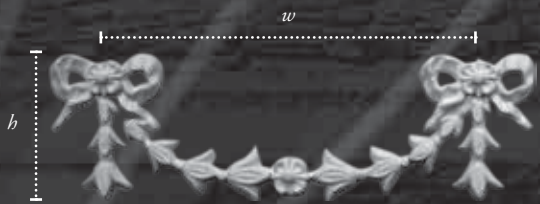

947 5 1/2(w)" x 2"(h)
140mm x 51mm

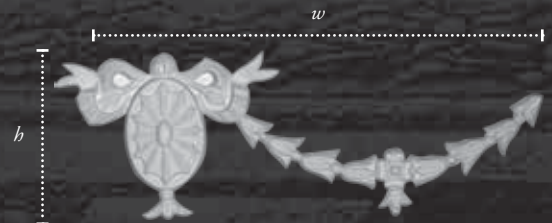

944 8"(w)" x 3"(h)
203mm x 76mm

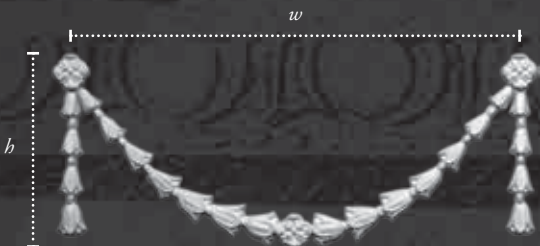

949 10 1/2(w)" x 4"(h)
267mm x 102mm

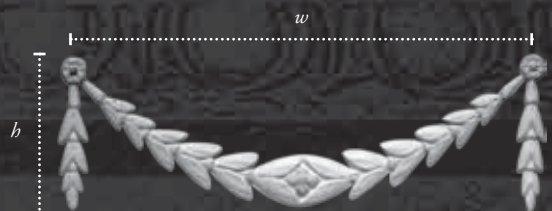

943 11"(w)" x 3 1/2"(h)
279mm x 89mm

height (h) x projection (p)

Rosettes



952 \varnothing 2 1/2"
64mm



968 \varnothing 3"
76mm



953 \varnothing 2 1/4"
57mm



955 \varnothing 4 1/2"
114mm



954 \varnothing 3 1/2"
89mm



965 \varnothing 4"
102mm



970 \varnothing 2 1/2"
64mm



975 \varnothing 3 1/2"
89mm



978 $\varnothing 4 \frac{1}{4}''$
108mm



973 $3 \frac{1}{4}''(l) \times 3 \frac{1}{4}''(w)$
83mm x 83mm



972 $\varnothing 3 \frac{1}{2}''$
89mm



951 $4(1)'' \times 4(w)''$
102mm x 102mm



977 $3''(l) \times 3''(w)$
76mm x 76mm



974 $3 \frac{1}{2}''(l) \times 3 \frac{1}{2}''(w)$
89mm x 89mm



964 $4 \frac{3}{4}''(l) \times 3 \frac{3}{4}''(w)$
121mm x 95mm



971 $3 \frac{3}{4}''(l) \times 2 \frac{1}{2}''(w)$
92mm x 64mm

height (h) x projection (p)



963 5" (l) x 3 3/4" (w)
127mm x 92mm



956 Ø 5 5/8"
143mm



984 Ø 5 3/4"
146mm



980 Ø 8 1/2"
216mm



981 Ø 5 1/2"
140mm



979 Ø 9"
229mm



983 \varnothing 9 1/2"
241mm



957 \varnothing 7 9/16"
192mm



958 \varnothing 6 3/4"
171mm



969 \varnothing 9 3/4"
248mm



962 \varnothing 7"
178mm



973 8 1/8" (l) x 8 1/8" (w)
206mm x 206mm

height (h) x projection (p)



950 \varnothing 10 1/2"
267mm



985 5 1/2"(l) x 5 1/2"(w)
140mm x 140mm



959 \varnothing 7 1/2"
191mm



966 5"(l) x 5"(w)
127mm x 127mm



961 10 1/2"(l) x 10 1/2"(w)
267mm x 267mm



960 7 1/2"(l) x 7 1/2"(w)
191mm x 191mm



967 6 1/2"(l) x 6 1/2"(w)
165mm x 165mm



976 7"(l) x 7"(w)
178mm x 178mm



Domes

CONTENTS

Plain Domes	page 72
Coffered Domes	page 73
Dome Rims	page 74
Dome Light Troughs	page 75

height (h) x projection (p)

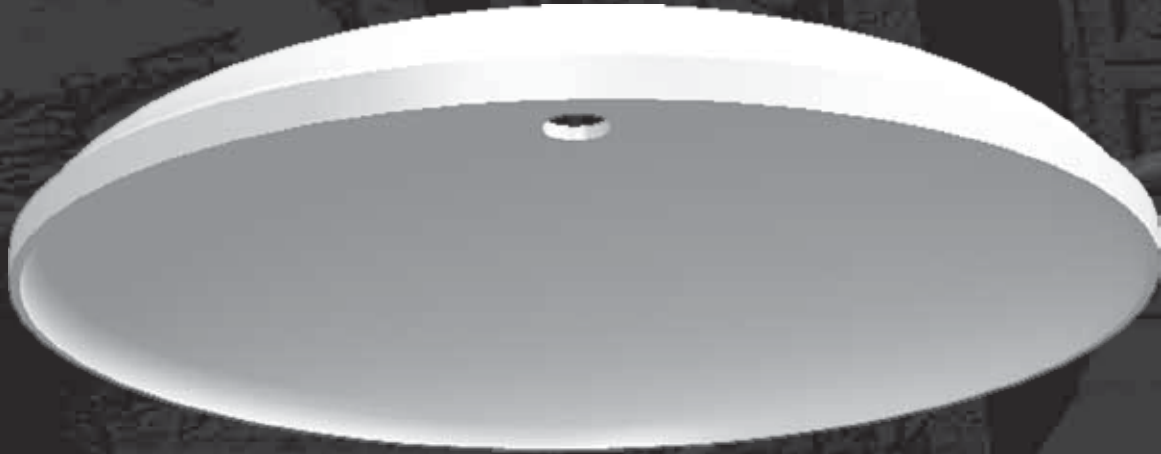

Part No.	Diameter		Height	
601	36"	914mm	8"	203mm
602	48"	1219mm	8"	203mm
603	60"	1524mm	8"	203mm
604	72"	1829mm	12"	305mm
605	114"	1896mm	14"	356mm

height (h) x projection (p)



height (h) x projection (p)

Dome Rings (shown w/ cutaway view)



630 3"(w) x 1 1/2"(h)
76mm x 38mm



631 4"(w) x 1"(h)
102mm x 25mm



632 3"(w) x 13/16"(h)
76mm x 21mm

Dome Light Troughs (shown w/ cutaway view)

▲ = light source



620 5 1/2" (w) x 4" (h)
140mm x 102mm

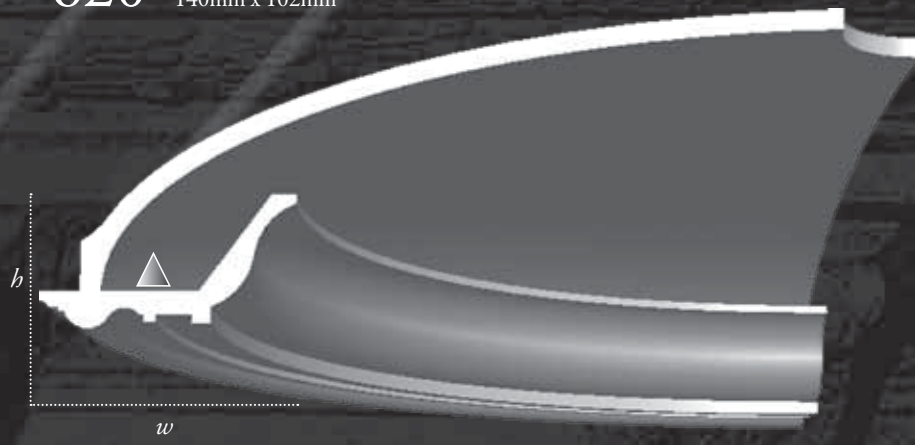

621 7 1/2" (w) x 4" (h)
191mm x 102mm

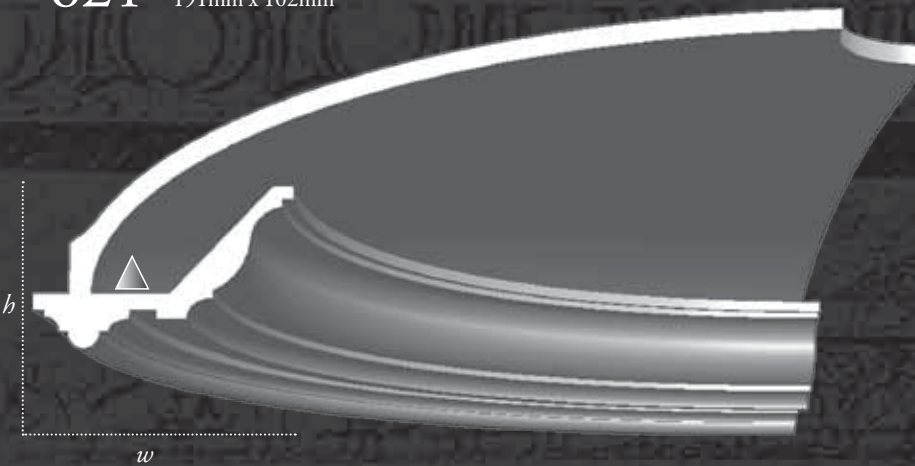

622 7 1/2" (w) x 4 3/4" (h)
191mm x 121mm



Columns

CONTENTS

Column Shafts	page 78-81
Capitals & Bases	page 82-83
Pilaster Shafts	page 84-87
Capitals & Bases	page 88-89
Capitals	page 90-91

height (h) x projection (p)



500



501

500: Standard Straight Shafts

Part No.	Height		Outside Ø		Inside Ø	
500 A	84"	2134mm	4"	102mm	3"	68mm
500 B	96"	2438mm	6"	152mm	5"	113mm
500 C	108"	2743mm	8"	203mm	7"	158mm
500 D	120"	3048mm	10"	254mm	9"	203mm
500 E	120"	3048mm	12"	305mm	11"	248mm

501: Standard Entasis Shafts

Part No.	Height		Top Ø		Bottom Ø		Inside Ø	
501 A	84"	2134mm	4"	102mm	4 13/16"	106mm	2 1/2"	64mm
501 B	96"	2438mm	6"	152mm	7 3/16"	183mm	4 1/2"	114mm
501 C	108"	2743mm	8"	203mm	9 5/8"	244mm	6 1/2"	165mm
501 D	120"	3048mm	10"	254mm	12"	305mm	8"	203mm
501 E	120"	3048mm	12"	305mm	14 3/8"	365mm	10"	254mm

height (h) x projection (p)

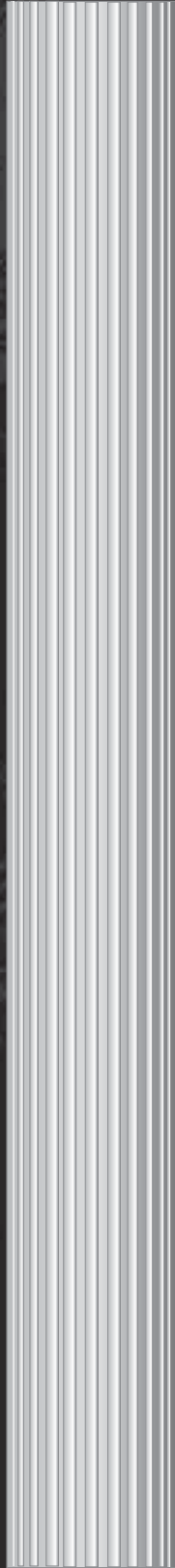

502



503



504

502: Fluted Straight Shafts

Part No.	Height		Outside Ø		Inside Ø	
502 A	84"	2134mm	4"	102mm	2 1/2"	64mm
502 B	96"	2438mm	6"	152mm	4 1/2"	114mm
502 C	108"	2743mm	8"	203mm	6 1/2"	165mm
502 D	120"	3048mm	10"	254mm	8"	203mm
502 E	120"	3048mm	12"	305mm	10"	254mm

503: Fluted Straight Shafts (w/ endflutes)

Part No.	Height		Outside Ø		Inside Ø		Top Endflute	Bottom Endflute
503 A	84"	2134mm	4"	102mm	2 1/2"	64mm	3/4" 19mm	3 3/4" 95mm
503 B	96"	2438mm	6"	152mm	4 1/2"	114mm		
503 C	108"	2743mm	8"	203mm	6 1/2"	165mm		
503 D	120"	3048mm	10"	254mm	8"	203mm		
503 E	120"	3048mm	12"	305mm	10"	254mm		

504: Fluted Entasis Shafts (w/ endflutes)

Part No.	Height		Top Ø		Bottom Ø		Inside Ø		Top Endflute	Bottom Endflute
504 A	84"	2134mm	4"	102mm	4 13/16"	122mm	2 1/2"	64mm	3/4" 19mm	3 3/4" 95mm
504 B	96"	2438mm	6"	152mm	7 3/16"	183mm	4 1/2"	114mm		
504 C	108"	2743mm	8"	203mm	9 5/8"	244mm	6 1/2"	165mm		
504 D	120"	3048mm	10"	254mm	12"	305mm	8"	203mm		
504 E	120"	3048mm	12"	305mm	14 3/8"	365mm	10"	254mm		

height (h) x projection (p)



Tuscan Column Capitals

Part No.	Outside		Height		Width (Top)	
	Height	Projection	Height	Projection	Width	Projection
525 A	4"	102mm	2 13/16"	71mm	6"	152mm
525 B	6"	152mm	4 1/4"	108mm	8 15/16"	227mm
525 C	8"	203mm	5 11/16"	143mm	11 15/16"	303mm
525 D	10"	254mm	7 1/8"	181mm	14 15/16"	379mm
525 E	12"	305mm	8 1/2"	216mm	17 15/16"	456mm



Ionic Column Capitals

Part No.	Outside Ø		Height		Max. Width	
	Height	Projection	Height	Projection	Width	Projection
526 A	4"	102mm	2"	51mm	7 1/2"	191mm
526 B	6"	152mm	3"	76mm	10"	254mm
526 C	8"	203mm	4 1/8"	105mm	13 1/2"	343mm
526 D	10"	254mm	5 1/8"	130mm	15"	381mm
526 E	12"	305mm	6 1/8"	156mm	18 3/4"	476mm



Corinthian Column Capitals

Part No.	Outside Ø		Height		Max. Width	
	Height	Projection	Height	Projection	Width	Projection
527 A	4"	102mm	6"	152mm	7 3/16"	183mm
527 B	6"	152mm	10 1/2"	268mm	10 3/8"	264mm
527 C	8"	203mm	12"	305mm	14 3/8"	365mm
527 D	10"	254mm	15"	381mm	18"	457mm
527 E	12"	305mm	18"	457mm	21 1/8"	638mm

Single Bullnose Column Base



Part No.	Outside Ø		Max. Ø		Height	
	in	mm	in	mm	in	mm
515 A	4"	102mm	5 5/16"	135mm	2"	51mm
515 B	6"	152mm	8"	203mm	3"	76mm
515 C	8"	203mm	10 11/16"	271mm	4"	102mm
515 D	10"	254mm	13 5/16"	338mm	5"	127mm
515 E	12"	305mm	16"	406mm	6"	152mm

Double Bullnose Column Base

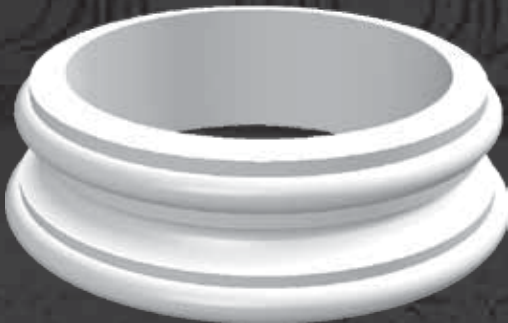

Part No.	Outside Ø		Max. Ø		Width (Top)	
	in	mm	in	mm	in	mm
516 A	4"	102mm	5 5/16"	135mm	1 5/16"	33mm
516 B	6"	152mm	8"	203mm	2"	51mm
516 C	8"	203mm	10 11/16"	270mm	2 11/16"	67mm
516 D	10"	254mm	13 5/16"	338mm	3 5/16"	84mm
516 E	12"	305mm	16"	406mm	4"	102mm

height (h) x projection (p)



508



509

508: Standard Straight Pilasters

Part No.	Height		Width		Depth	
508 A	84"	2134mm	4"	102mm	2"	51mm
508 B	96"	2438mm	6"	152mm	3"	76mm
508 C	108"	2743mm	8"	203mm	4"	102mm
508 D	120"	3048mm	10"	254mm	5"	127mm
508 E	120"	3048mm	12"	305mm	6"	152mm

509: Standard Entasis Pilasters

Part No.	Height		Top Width		Bottom Width		Top Depth		Bottom Depth	
509 A	84"	2134mm	4"	102mm	4 13/16"	122mm	2"	51mm	2 3/8"	60mm
509 B	96"	2438mm	6"	152mm	7 3/16"	183mm	3"	76mm	3 1/2"	89mm
509 C	108"	2743mm	8"	203mm	9 5/8"	244mm	4"	102mm	4 13/16"	122mm
509 D	120"	3048mm	10"	254mm	12"	305mm	5"	127mm	6"	152mm
509 E	120"	3048mm	12"	305mm	14 3/8"	365mm	6"	152mm	7 3/16"	183mm

height (h) x projection (p)



510



511



512

510: Fluted Straight Pilasters

Part No.	Height		Width		Depth	
	in	mm	in	mm	in	mm
510 A	84"	2134mm	4"	102mm	2"	51mm
510 B	96"	2438mm	6"	152mm	3"	76mm
510 C	108"	2743mm	8"	203mm	4"	102mm
510 D	120"	3048mm	10"	254mm	5"	127mm
510 E	120"	3048mm	12"	305mm	6"	152mm

511: Fluted Straight Pilasters (w/ endflutes)

Part No.	Height		Width		Depth		Top Endflute	Bottom Endflute
	in	mm	in	mm	in	mm		
511 A	84"	2134mm	4"	102mm	2"	51mm	3/4" 19mm	3 3/4" 95mm
511 B	96"	2438mm	6"	152mm	3"	76mm		
511 C	108"	2743mm	8"	203mm	4"	102mm		
511 D	120"	3048mm	10"	254mm	5"	127mm		
511 E	120"	3048mm	12"	305mm	6"	152mm		

512: Fluted Entasis Pilasters (w/ endflutes)

Part No.	Height		Top Width		Bottom Width		Top Depth		Bottom Depth		Top Endflute	Bottom Endflute
	in	mm	in	mm	in	mm	in	mm	in	mm		
512 A	84"	2134mm	4"	102mm	4 13/16"	106mm	2"	51mm	2 3/8"	60mm	3/4" 19mm	3 3/4" 95mm
512 B	96"	2438mm	6"	152mm	7 3/16"	183mm	3"	76mm	3 1/2"	89mm		
512 C	108"	2743mm	8"	203mm	9 5/8"	244mm	4"	102mm	4 13/16"	122mm		
512 D	120"	3048mm	10"	254mm	12"	305mm	5"	127mm	6"	152mm		
512 E	120"	3048mm	12"	305mm	14 3/8"	365mm	6"	152mm	7 3/16"	183mm		

height (h) x projection (p)



Tuscan Pilaster Capitals

Part No.	Depth		Width		Height		Max. Width	
528 A	2"	51mm	4"	102mm	2 13/16"	71mm	6"	152mm
528 B	3"	76mm	6"	152mm	4 1/4"	108mm	9"	229mm
528 C	4"	106mm	8"	203mm	5 11/16"	144mm	12"	305mm
528 D	5"	127mm	10"	254mm	7 1/8"	181mm	15"	381mm
528 E	6"	153mm	12"	305mm	8 1/2"	216mm	18"	457mm



Ionic Pilaster Capitals

Part No.	Depth		Width		Height		Max. Width	
530 A	2"	51mm	4"	102mm	2"	51mm	7 1/2"	191mm
530 B	3"	76mm	6"	152mm	3"	76mm	10"	254mm
530 C	4"	106mm	8"	203mm	4"	105mm	13 1/2"	343mm
530 D	5"	127mm	10"	254mm	5"	130mm	15"	381mm
530 E	6"	153mm	12"	305mm	6"	156mm	18 3/4"	476mm



Corinthian Pilaster Capitals

Part No.	Depth		Width		Height		Max. Width	
529 A	2"	51mm	4"	106mm	6"	152mm	7 3/16"	183mm
529 B	3"	76mm	6"	152mm	10 1/2"	267mm	10 3/8"	264mm
529 C	4"	106mm	8"	203mm	12"	305mm	14 3/8"	365mm
529 D	5"	127mm	10"	254mm	15"	381mm	18"	457mm
529 E	6"	152mm	12"	305mm	18"	457mm	21 5/8"	549mm

Single Bullnose Pilaster Base

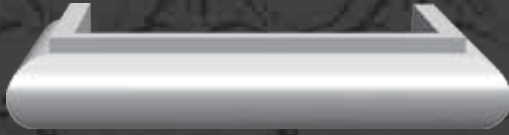

Part No.	Width		Max. Width		Height	
	in	mm	in	mm	in	mm
519 A	4"	102mm	5 5/16"	135mm	2"	51mm
519 B	6"	152mm	8"	203mm	3"	76mm
519 C	8"	203mm	10 11/16"	271mm	4"	102mm
519 D	10"	254mm	13 5/16"	338mm	5"	127mm
519 E	12"	305mm	16"	406mm	6"	152mm

Double Bullnose Pilaster Base



Part No.	Width		Max. Width		Height	
	in	mm	in	mm	in	mm
520 A	4"	102mm	5 5/16"	135mm	1 5/16"	33mm
520 B	6"	152mm	8"	203mm	2"	51mm
520 C	8"	203mm	10 11/16"	271mm	2 11/16"	68mm
520 D	10"	254mm	13 5/16"	338mm	3 5/16"	84mm
520 E	12"	305mm	16"	406mm	4"	102mm

height (h) x projection (p)



556 16 1/2"(w) x 4 3/4"(d) x 17 1/4"(h)
419mm x 121mm x 438mm

Fits an 11"(w) x 2"(d) pilaster
279mm x 51mm



555 17 1/2"(w) x 5 1/2"(d) x 13"(h)
445mm x 140mm x 330mm

Fits a 12"(w) x 2 3/4"(d) pilaster
305mm x 70mm



557 11"(w) x 2 1/2"(d) x 9"(h)
279mm x 64mm x 229mm

Fits a 7 1/2"(w) x 1"(d) pilaster
191mm x 25mm



552 21 3/4"(w) x 6"(d) x 12"(h)
552mm x 152mm x 305mm

Fits an 11 1/2"(w) x 1 1/4"(d) pilaster
279mm x 32mm



558 19"(w) x 19"(w) x 7 3/4"(h)
483mm x 483mm x 197mm
Fits a 12" / 305mm column



554 16"(w) x 16"(d) x 9 3/4"(h)
406mm x 406mm x 248mm
Fits an 8" / 203mm column





Brackets

height (h) x projection (p)



406 8 1/8"(h) x 10"(w) x 11 1/2"(p)
206mm x 254mm x 292mm



407 4 7/8"(h) x 8 1/2"(w) x 5 1/4"(p)
124mm x 216mm x 133mm



408 5 1/2"(h) x 6 1/4"(w) x 14 3/4"(p)
140mm x 159mm x 375mm



405 5 5/8"(h) x 5 1/4"(w) x 7 1/2"(p)
143mm x 133mm x 191mm



401 2 1/2"(h) x 3 5/8"(w) x 4 3/4"(p)
64mm x 92mm x 121mm



411 9 1/2"(h) x 7"(w) x 4 3/8"(p)
241mm x 178mm x 111mm



402 11"(h) x 2 3/4"(w) x 1 3/4"(p)
279mm x 70mm x 44mm



403 11"(h) x 2 3/4"(w) x 1 3/4"(p)
279mm x 70mm x 44mm



400 16"(h) x 6 3/8"(w) x 8"(p)
406mm x 162mm x 203mm



404 12"(h) 5 1/8"(w) x 5 3/4"(p)
305mm x 130mm x 146mm

height (h) x projection (p)



409 19 1/4"(h) x 12"(w) x 10 1/4"(p)
489mm x 305mm x 260mm



410 10"(h) x 3 9"(w) x 4"(p)
254mm x 229mm x 102mm



412 36"(h) x 14 1/2"(w) x 12"(p)
914mm x 368mm x 305mm



414 7 1/2"(h) x 5 3/4"(w) x 3 1/8"(p)
191mm x 146mm x 79mm

height (h) x projection (p)



412 10"(h) x 9"(w) x 4"(p)
254mm x 229mm x 107mm





Ceiling Tiles

height (h) x projection (p)

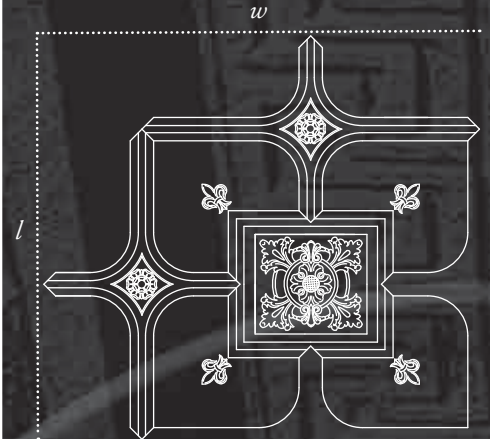

650 43 5/8"(l) x 40 3/8"(w)
1108mm x 1026mm

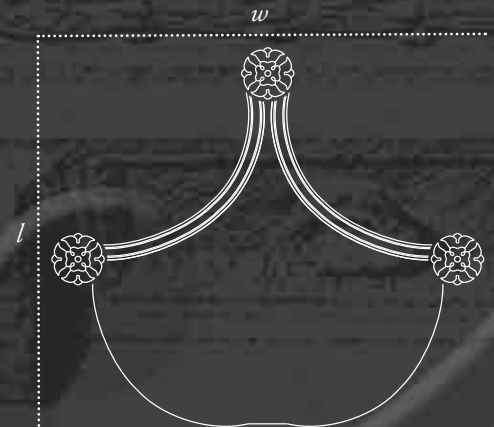
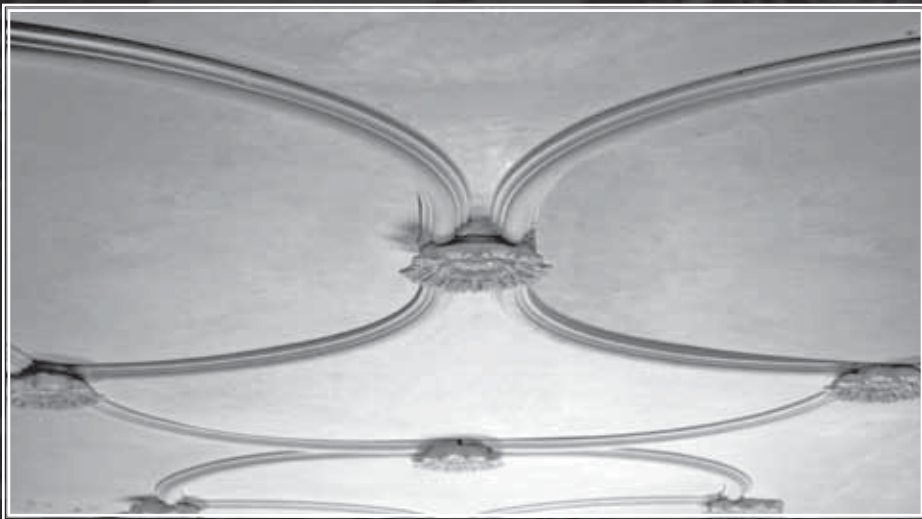

652 46 1/8"(l) x 49"(w)
1172mm x 1245mm

Optional Rosettes:



962



969



959

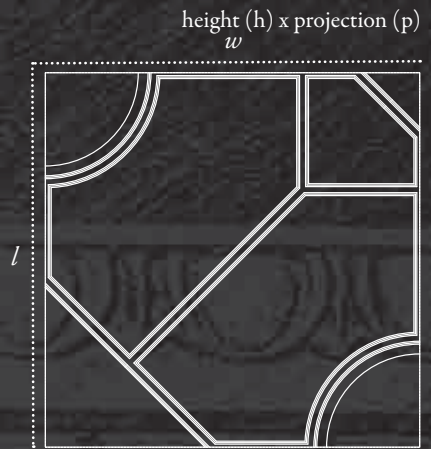

651 48" (l) x 48" (w)
1219mm x 1219mm





Sculpting

&

Patterns

height (h) x projection (p)

Custom Work



One of Longchamps Architecturals Inc.'s most precious assets is in the area of custom sculpting and pattern making. We have built a solid reputation based on our abilities to shape the minute splendors of an Acanthus leaf to constructing the grandeur of a large coffered dome.

Our areas of specialty consist of:

Sculptures

Pattern-making

Restorations

Renovations

Our systematic approach to custom work develops in 4 stages:
Concept, Engineering, Sculpting and Production.



Concept

Virtually anything from a painting, a photo, an artifact or even a general idea can skillfully be molded in plaster.

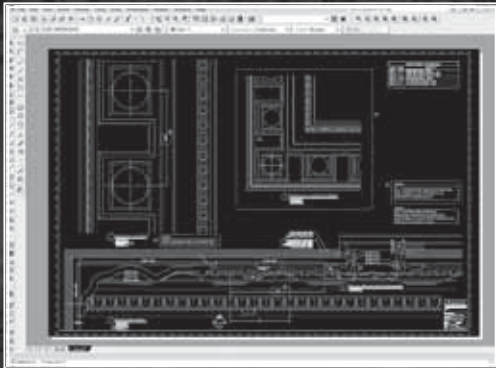

Engineering

Your concept is drawn using advanced CAD software and devices to accurately detail shapes, curves, angles, repetitions and measurements.



Sculpting

Our finest sculptors engage their mastery and skill in creating the concept.

Using renderings and CAD drawings matched with our exceptional artistic techniques we can produce endless possibilities that create your distinctive masterpieces.



Production

Once a silicone mold or running steel is made, our expert craftsmen manufacture your parts using special moulding plaster and sufficiently reinforce it with strong supporting materials such as fiberglass and burlap.

Final Product



Sculptures produced from a painting



A partial of an entire room replicated from a photograph





A reproduction of a frieze from a book

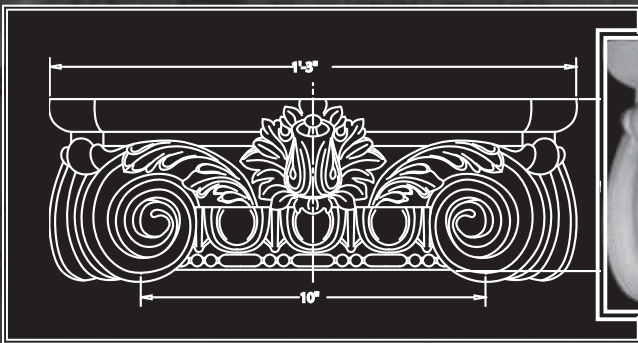

An Ionic Capital sculpted from a CAD drawing

Product Index

Part	Page										
100		157	6	216	25	256	27	331	12	529 A-E	89
103	13	158	6	217	28	257	27	332	12	530 A-E	89
108	15	159	8	218	22	258	28	333	12	552	90
110	13	160	10	219	22	259	25	334	12	554	91
111	8	161	9	220	23	260	20	335	12	555	90
112	15	163	8	221	28	261	19	400		556	90
114	8	164	6	222	16	262	24	400	95	557	90
115	8	165	6	223	16	263	27	401	94	558	91
116	14	167	7	224	17	264	17	402	95	600	
117	14	168	8	225	18	265	24	403	95	601	72
118	9	170	8	226	18	266	28	404	95	602	72
119	9	172	15	227	22	267	25	405	94	603	72
125	7	174	9	228	18	268	29	406	94	604	72
126	7	175	9	229	24	300		407	94	605	72
127	7	176	6	230	21	300	10	408	94	606	73
128	14	177	6	231	22	301	10	409	96	620	75
129	10	178	6	232	19	302	10	410	96	621	75
130	13	179	6	233	26	306	11	411	94	622	75
131	13	180	6	234	21	307	11	412	96	630	74
133	7	181	7	235	20	308	11	414	96	631	75
134	7	182	7	236	21	309	11	500		632	75
135	7	183	7	237	28	310	11	500 A-E	79	650	100
136	7	184	7	238	29	311	11	501 A-E	79	652	100
137	10	200		239	22	312	11	502 A-E	81	652	100
141	9	200	16	240	25	313	11	503 A-E	81		
142	9	201	16	241	19	314	11	504 A-E	81	700	40
143	9	202	16	242	19	315	11	508 A-E	85	701	40
144	9	203	17	243	26	316	11	509 A-E	85	702	40
145	6	204	17	244	26	317	11	510 A-E	87	703	41
146	7	205	18	245	19	318	11	511 A-E	87	704	41
147	15	206	18	247	23	319	11	512 A-E	87	705	40
149	10	207	20	248	26	320	11	515 A-E	83	706	41
150	14	208	21	249	20	324	12	516 A-E	83	707	40
151	14	209	20	250	17	325	12	519 A-E	89	707-C	51
152	6	210	21	251	23	326	12	520 A-E	89	708	42
153	6	211	24	252	29	327	12	525 A-E	82	709	41
154	6	212	24	253	29	328	12	526 A-E	82	710	42
155	7	213	23	254	27	329	12	527 A-E	82	711	42
156	6	215	25	255	27	330	12	528 A-E	88		

Part	Page								
712	42	769	45	807	34	851	35	948	63
713	42	770	45	808	34	900		949	63
714	43	771	46	809	32	900	56	950	68
715	43	772	46	811	33	901	60	951	65
716	42	772-C	53	812	34	902	56	952	64
717	43	773	45	814	35	903	57	953	64
718	42	774	45	816	33	904	57	954	64
719	43	775	48	817	34	905	59	955	64
720	40	776	45	818	32	906	57	956	66
721	40	776-C	53	819	32	907	59	957	67
722	40	777	45	820	32	908	58	958	67
723	41	777-C	50	821	34	909	57	959	68
724	41	778	48	822	33	910	58	960	68
725	40	779	48	823	34	911	59	961	68
725-C	51	780	49	824	33	912	59	962	67
726	41	781	46	825	33	913	57	963	66
726-C	52	782	47	826	32	914	56	964	65
727	41	783	47	827	33	915	56	965	64
727-C	52	784	47	828	37	916	58	966	68
728	41	785	47	829	33	917	59	967	69
729	41	786	47	830	32	918	57	968	64
729-C	51	787	47	831	34	919	60	969	67
750	46	788	47	832	32	920	58	970	64
752	46	789	48	833	35	922	58	971	65
753	48	790	49	834	37	923	56	972	65
754	44	790-C	50	836	36	924	57	973	65
755	44	791	49	837	36	925	61	974	65
756	44	792	49	838	36	926	58	975	64
757	44	793	49	839	33	927	56	976	69
758	44	793-C	50	840	37	928	62	977	65
760	46	794	49	842	32	929	62	978	65
761	46	795	49	843	47	930	62	979	66
762	46	796	45	844	57	931	61	980	66
763	44	800		845	32	932	60	981	66
764	44	800	35	846	47	943	63	982	67
765	48	801	37	847	48	944	63	983	67
766	44	802	35	848	47	945	63	984	66
767	45	804	34	849	47	946	63	985	68
768	45	805	33	850	35	947	63		



www.longchamparchitectural.com